

ZWISCHENHÜLSEN

extra schmale Weldonfutter

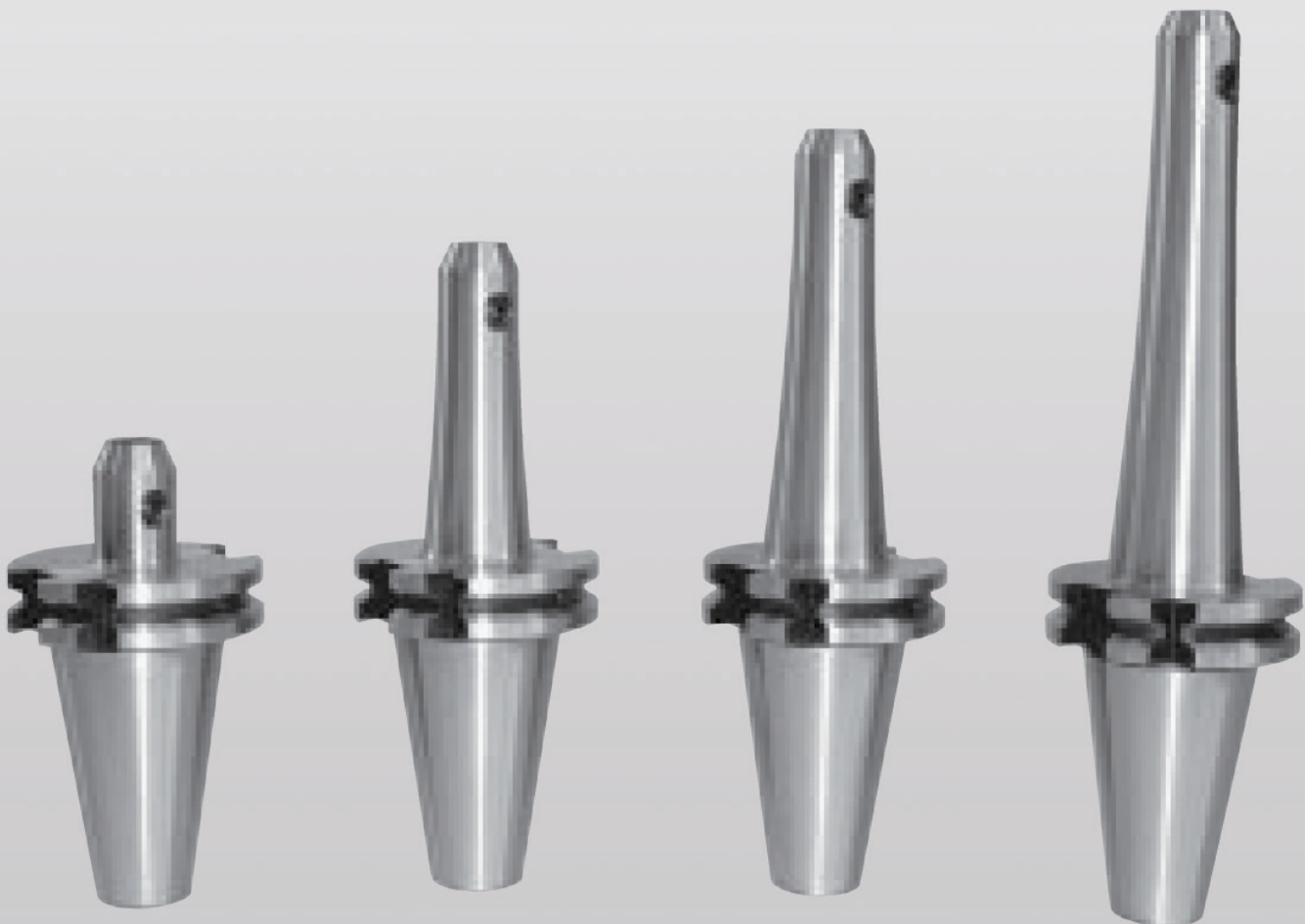

Zwischenhülsen DIN 6359

Verwendung: Zum Spannen von Werkzeugen mit Zylinderschaft DIN 1835 Form B
Lieferumfang: Mit eingebauter Spannschraube, ab \varnothing 25 mit zwei Spannschrauben

SK40 / MAS BT ADB	Seite 3
SK40 / DIN 69871 ADB	Seite 4
SK50 / DIN 69871 ADB	Seite 5
HSK-A63 / ISO 12164 A+C	Seite 6
HSK-A100 / ISO 12164 A+C	Seite 7

Hinweis Preisgültigkeit:

Aufgrund der extremen Entwicklungen der Material- und Rohstoffpreise sind kurzfristige Preisänderungen möglich!

Zwischenhülsen DIN 6359 - SK40 / MAS BT ADB

für Zylinderschäfte DIN 1835 B (Weldon)

SK 40

MAS BT ADB

Pre-balanced

G6,3 - 8.000 r.p.m.

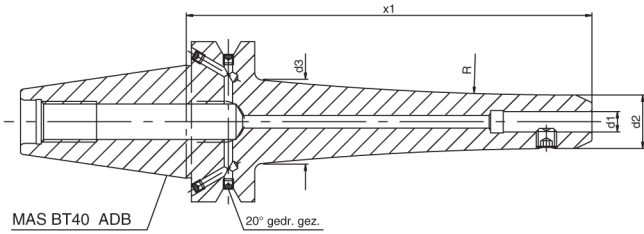
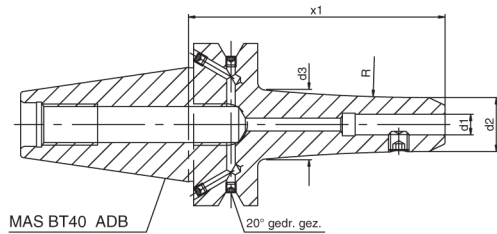

Art.-Nr.	SK	d ₁	x1	d ₂	d ₃	Preis (€)
33.041.006WF	40	6	100	17	23	60,00
33.041.306WF	40	6	130	17	28	65,00
33.041.606WF	40	6	160	17	29	70,00
33.041.008WF	40	8	100	21	27	60,00
33.041.308WF	40	8	130	21	32	65,00
33.041.608WF	40	8	160	21	33	70,00
33.041.010WF	40	10	100	24	30	60,00
33.041.310WF	40	10	130	24	35	65,00
33.041.610WF	40	10	160	24	36	70,00
33.041.012WF	40	12	100	27	33	60,00
33.041.312WF	40	12	130	27	38	65,00
33.041.612WF	40	12	160	27	39	70,00
33.041.014WF	40	14	100	29	35	60,00
33.041.314WF	40	14	130	29	40	65,00
33.041.614WF	40	14	160	29	41	70,00
33.041.016WF	40	16	100	33	39	60,00
33.041.316WF	40	16	130	33	44	65,00
33.041.616WF	40	16	160	33	45	70,00
33.041.018WF	40	18	100	35	41	60,00
33.041.318WF	40	18	130	35	46	65,00
33.041.618WF	40	18	160	35	47	70,00
33.041.020WF	40	20	100	39	45	60,00
33.041.320WF	40	20	130	39	48	65,00
33.041.620WF	40	20	160	39	49	70,00
33.041.025WF	40	25	100	47	47	65,00
33.041.325WF	40	25	130	47	47	70,00
33.041.625WF	40	25	160	47	47	75,00
33.041.032WF	40	32	100	57	57	65,00
33.041.332WF	40	32	130	57	57	70,00
33.041.632WF	40	32	160	57	57	75,00

Zwischenhülsen DIN 6359 - SK40 / DIN 69871 ADB

für Zylinderschäfte DIN 1835 B (Weldon)

SK 40

DIN 69871 ADB

Pre-balanced

G6,3 - 8.000 r.p.m.



Art.-Nr.	SK	d ₁	x1	d ₂	d ₃	Preis (€)
33.410.106WF	40	6	100	17	25	60,00
33.413.106WF	40	6	130	17	30	65,00
33.416.106WF	40	6	160	17	31	70,00
33.410.108WF	40	8	100	21	29	60,00
33.413.108WF	40	8	130	21	34	65,00
33.416.108WF	40	8	160	21	35	70,00
33.410.110WF	40	10	100	24	32	60,00
33.413.110WF	40	10	130	24	37	65,00
33.416.110WF	40	10	160	24	38	70,00
33.410.112WF	40	12	100	27	35	60,00
33.413.112WF	40	12	130	27	40	65,00
33.416.112WF	40	12	160	27	41	70,00
33.410.114WF	40	14	100	29	37	60,00
33.413.114WF	40	14	130	29	42	65,00
33.416.114WF	40	14	160	29	43	70,00
33.410.116WF	40	16	100	33	41	60,00
33.413.116WF	40	16	130	33	46	65,00
33.416.116WF	40	16	160	33	47	70,00
33.410.118WF	40	18	100	35	43	60,00
33.413.118WF	40	18	130	35	48	65,00
33.416.118WF	40	18	160	35	49	70,00
33.410.120WF	40	20	100	39	47	60,00
33.413.120WF	40	20	130	39	50	65,00
33.416.120WF	40	20	160	39	50	70,00
33.410.125WF	40	25	100	47	47	65,00
33.413.125WF	40	25	130	47	47	70,00
33.416.125WF	40	25	160	47	47	75,00
33.410.132WF	40	32	100	57	57	65,00
33.413.132WF	40	32	130	57	57	70,00
33.416.132WF	40	32	160	57	57	75,00

Zwischenhülsen DIN 6359 - SK50 / DIN 69871 ADB

für Zylinderschäfte DIN 1835 B (Weldon)

SK 50

DIN 69871 ADB

Pre-balanced

G6,3 - 8.000 r.p.m.

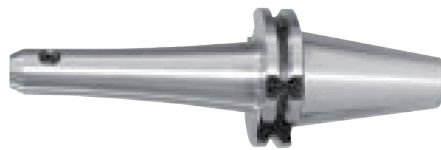

Art.-Nr.	SK	d ₁	x1	d ₂	d ₃	Preis (€)
33.520.125WF	50	25	200	47	70	150,00
33.513.132WF	50	32	130	57	70	90,00
33.516.132WF	50	32	160	57	71	100,00
33.520.132WF	50	32	200	57	72	150,00
33.510.106WF	50	6	100	17	25	80,00
33.513.106WF	50	6	130	17	30	90,00
33.516.106WF	50	6	160	17	31	100,00
33.520.106WF	50	6	200	17	40	150,00
33.510.108WF	50	8	100	21	29	80,00
33.513.108WF	50	8	130	21	34	90,00
33.516.108WF	50	8	160	21	35	100,00
33.520.108WF	50	8	200	21	44	150,00
33.510.110WF	50	10	100	24	32	80,00
33.513.110WF	50	10	130	24	37	90,00
33.516.110WF	50	10	160	24	38	100,00
33.520.110WF	50	10	200	24	47	150,00
33.510.112WF	50	12	100	27	35	80,00
33.513.112WF	50	12	130	27	40	90,00
33.516.112WF	50	12	160	27	41	100,00
33.520.112WF	50	12	200	27	50	150,00
33.510.114WF	50	14	100	29	37	80,00
33.513.114WF	50	14	130	29	42	90,00
33.516.114WF	50	14	160	29	43	100,00
33.520.114WF	50	14	200	29	52	150,00
33.510.116WF	50	16	100	33	41	80,00
33.513.116WF	50	16	130	33	46	90,00
33.516.116WF	50	16	160	33	47	100,00
33.520.116WF	50	16	200	33	56	150,00
33.510.118WF	50	18	100	35	43	80,00
33.513.118WF	50	18	130	35	48	90,00
33.516.118WF	50	18	160	35	49	100,00
33.520.118WF	50	18	200	35	58	150,00
33.510.120WF	50	20	100	39	47	80,00
33.513.120WF	50	20	130	39	52	90,00
33.516.120WF	50	20	160	39	53	100,00
33.520.120WF	50	20	200	39	62	150,00
33.510.125WF	50	25	100	47	55	80,00
33.513.125WF	50	25	130	47	60	90,00
33.516.125WF	50	25	160	47	61	100,00

Zwischenhülsen DIN 6359 - HSK-A63 / ISO 12164 A+C

für Zylinderschäfte DIN 1835 B (Weldon)

HSK-A63

ISO 12164 A+C

Pre-balanced

G6,3 - 18.000 r.p.m.

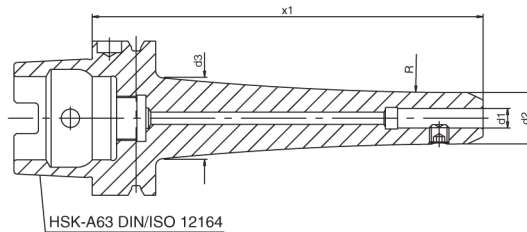
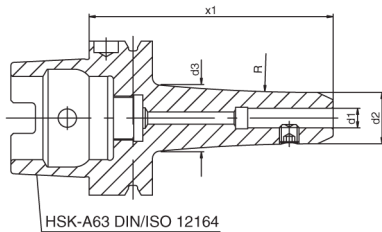

Art.-Nr.	HSK-A	d ₁	x1	d ₂	d ₃	Preis (€)
63A.106.065WF	63	6	65	17	17	95,00
63A.106.100WF	63	6	100	17	23	110,00
63A.106.130WF	63	6	130	17	28	115,00
63A.106.160WF	63	6	160	17	29	125,00
63A.108.065WF	63	8	65	21	21	95,00
63A.108.100WF	63	8	100	21	27	110,00
63A.108.130WF	63	8	130	21	32	115,00
63A.108.160WF	63	8	160	21	33	125,00
63A.110.065WF	63	10	65	24	24	95,00
63A.110.100WF	63	10	100	24	30	110,00
63A.110.130WF	63	10	130	24	35	115,00
63A.110.160WF	63	10	160	24	36	125,00
63A.112.080WF	63	12	80	27	27	95,00
63A.112.100WF	63	12	100	27	33	110,00
63A.112.130WF	63	12	130	27	38	115,00
63A.112.160WF	63	12	160	27	39	125,00
63A.114.080WF	63	14	80	29	29	95,00
63A.114.100WF	63	14	100	29	35	110,00
63A.114.130WF	63	14	130	29	40	115,00
63A.114.160WF	63	14	160	29	41	125,00
63A.116.080WF	63	16	80	33	33	95,00
63A.116.100WF	63	16	100	33	39	110,00
63A.116.130WF	63	16	130	33	44	115,00
63A.116.160WF	63	16	160	33	45	125,00
63A.118.080WF	63	18	80	35	35	95,00
63A.118.100WF	63	18	100	35	41	110,00
63A.118.130WF	63	18	130	35	46	115,00
63A.118.160WF	63	18	160	35	47	125,00
63A.120.080WF	63	20	80	39	39	95,00
63A.120.100WF	63	20	100	39	45	110,00
63A.120.130WF	63	20	130	39	50	115,00
63A.120.160WF	63	20	160	39	51	125,00
63A.125.100WF	63	25	100	47	47	115,00
63A.125.130WF	63	25	130	47	47	120,00
63A.125.160WF	63	25	160	47	47	130,00
63A.132.110WF	63	32	110	57	57	120,00
63A.132.160WF	63	32	160	57	57	135,00

Zwischenhülsen DIN 6359 - HSK-A100 / ISO 12164 A+C

für Zylinderschäfte DIN 1835 B (Weldon)

HSK-A63

ISO 12164 A+C

Pre-balanced

G6,3 - 18.000 r.p.m.



Art.-Nr.	HSK-A	d ₁	x1	d ₂	d ₃	Preis (€)
100A.106.130WF	100	6	130	17	26	130,00
100A.106.160WF	100	6	160	17	27	145,00
100A.106.200WF	100	6	200	17	37	160,00
100A.108.130WF	100	8	130	21	30	130,00
100A.108.160WF	100	8	160	21	32	145,00
100A.108.200WF	100	8	200	21	41	160,00
100A.110.130WF	100	10	130	24	33	130,00
100A.110.160WF	100	10	160	24	35	145,00
100A.110.200WF	100	10	200	24	44	160,00
100A.112.130WF	100	12	130	27	37	130,00
100A.112.160WF	100	12	160	27	38	145,00
100A.112.200WF	100	12	200	27	47	160,00
100A.114.130WF	100	14	130	29	39	130,00
100A.114.160WF	100	14	160	29	40	145,00
100A.114.200WF	100	14	200	29	49	160,00
100A.116.130WF	100	16	130	33	43	130,00
100A.116.160WF	100	16	160	33	44	145,00
100A.116.200WF	100	16	200	33	53	160,00
100A.118.130WF	100	18	130	35	45	130,00
100A.118.160WF	100	18	160	35	46	145,00
100A.118.200WF	100	18	200	35	55	160,00
100A.120.130WF	100	20	130	39	49	130,00
100A.120.160WF	100	20	160	39	50	145,00
100A.120.200WF	100	20	200	39	59	160,00
100A.125.130WF	100	25	130	47	57	130,00
100A.125.160WF	100	25	160	47	58	145,00
100A.125.200WF	100	25	200	47	67	160,00
100A.132.130WF	100	32	130	57	67	130,00
100A.132.160WF	100	32	160	57	68	145,00
100A.132.200WF	100	32	200	57	70	160,00

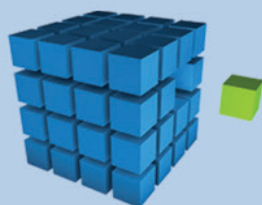
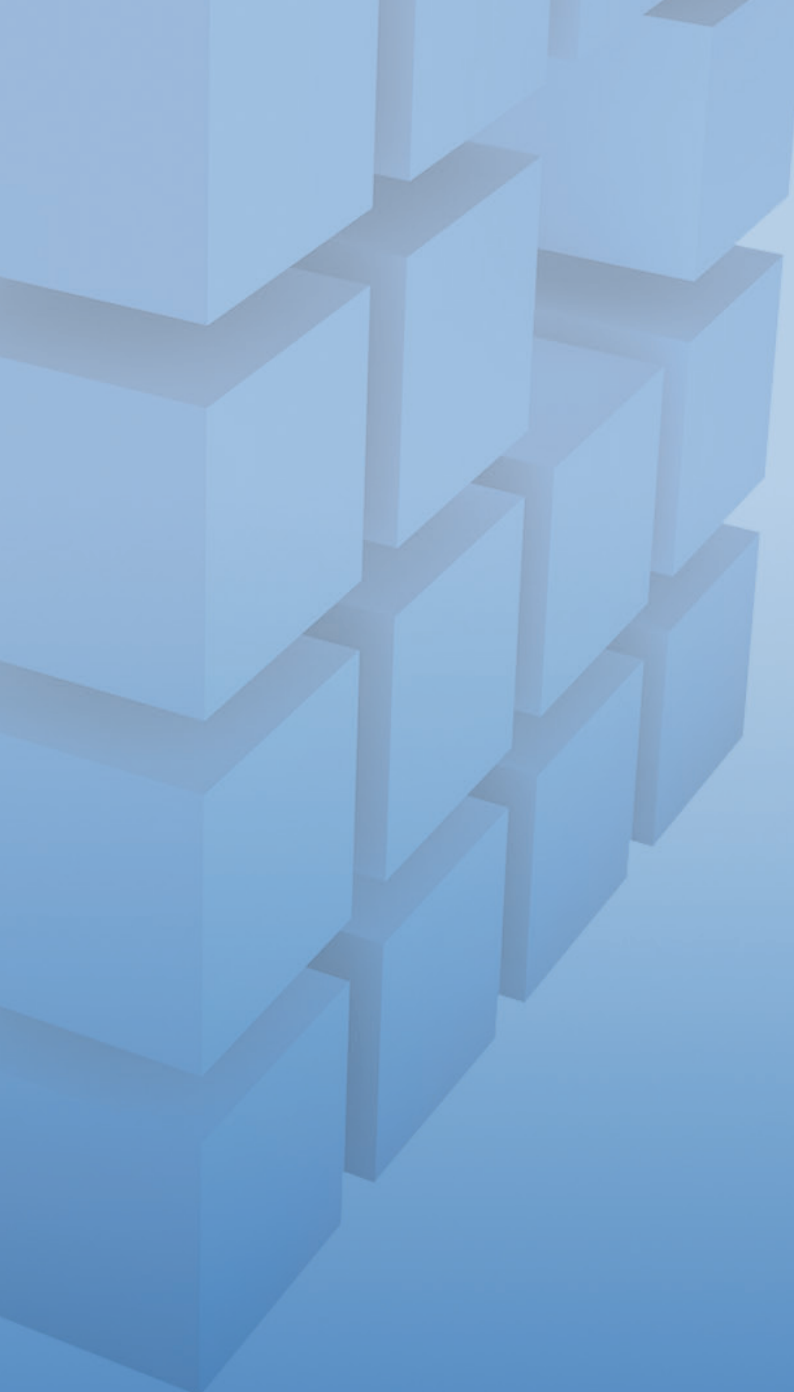

KROMER GmbH

Daimlerstrasse 28/1 · 72644 Oberboihingen
Telefon: 07022/96092-0 · Telefax: 07022/96092-34
Email: info@kromer-gmbh.de · www.kromer-gmbh.de

© by Kromer GmbH 2011

Technische Änderungen vorbehalten.
Für Druckfehler und Irrtümer keine Gewähr. Nachdruck von Texten, Bildern oder Grafiken, auch auszugsweise, ist ohne unsere vorherige schriftliche Genehmigung nicht gestattet.
Es haben ausschließlich unsere Verkaufs- und Lieferbedingungen Gültigkeit. Stand: September 2009
Mit dieser Preisliste verlieren vorherige Preislisten ihre Gültigkeit.